

# WATTCO™

Manufacturer of Electric Heating Elements and Controls

## CIRCULATION HEATERS immersion heaters

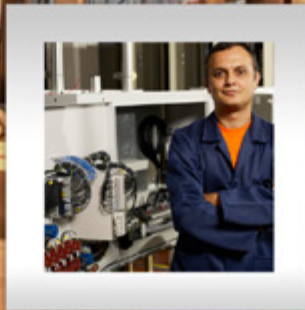
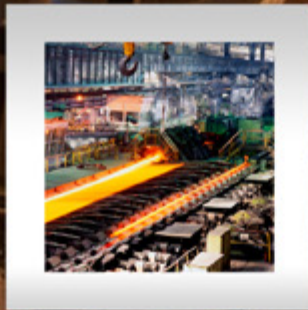

(1-888-226-8522)

[www.ProcessElectricHeaters.com](http://www.ProcessElectricHeaters.com)



## Over 50 years of proven designs

Wattco is a manufacturing company developing electric heating products for use around the world since 1969. With uncompromised dedication to our customers, we offer solutions and not just products. Our development in oil and gas industries, renewable energy, HVAC systems and government projects help customer like you to get alternative solutions for your projects to get off the ground in the most cost efficient way.



**Double Skid Mounted In-Line Heater**

---

### ***Our Vision:***

to be the industry benchmark.

---

### ***Our Solution:***

we have combined the global knowledge, history and experience to create the best heating elements.

# CIRCULATION HEATERS

## immersion heaters

### OVERVIEW

WATTCO™ circulation heaters are the perfect solution for generating heat and enhancing normal immersion heaters performance. They are designed to heat pressurized circulating fluids to provide effective, controlled heating to water, oil, steam and other gases.

Circulation heaters are composed of all-in-one units with a heater mounted inside an insulated tank. They are made of a flanged or a screwplug immersion heater that is inserted into a pressure vessel or a pipe body. Heaters have inlet and outlet piping where the liquid or gas goes through the tank in order to reach the desired temperature.

### KEY FEATURES

- » Standard sizes: 1.25" NPT screwplug size to 14" diameter
- » Steel vessels fitted with 150 lb. flanges
- » Thermal insulated vessels
- » Custom unit sizes: up to 44" nominal pipe size
- » Custom-designed to meet your specifications
- » Special sizes, wattages, and materials are available upon request
- » Units are available with larger vessels and heavier flanges
- » Supplied with stainless steel parts and special design terminal boxes for heat protection and use in high temperature conditions

### BENEFITS

- » Easy to install
- » Compact
- » Clean
- » Durable
- » Highly energy efficient
- » Provide fast response and even heat distribution
- » Provide greater wattage in a smaller heater bundle
- » Provide maximum dielectric strength
- » Reduce heat loss from the vessel
- » Protect and prevent thermal insulation
- » Easy mounting support
- » Suitable to general purpose terminal enclosures, weather or moisture resistant terminal enclosures, and unsafe or explosion proof locations
- » Compatible with standard industry piping and safety standards
- » Designed and built for safety



FIG.1 – WATTCO™ Standard Unit

### FACTORS

Please consider the following factors in order to select the proper circulation heater:

- » Operating temperature
- » Heating element watt density
- » Sheath material (corrosive or non corrosive)
  - Temperature of the corrodent
  - Degree of aeration of exposed corrodent
  - Velocity of the corrodent

### REGISTRATION

Circulation heaters are sometimes considered as boilers or pressure vessels according to the:

- » Heated fluid
- » KW rating
- » Size of vessel
- » Operating pressure
- » Outlet temperature

Where applicable, registration requirements are imposed by law and according to the installation location.

### EXTRA FEATURES

- » Available built-in high limit controls and thermostats
- » Standard built-in thermostats: Single pole device limited to 240V up to 30 amps
- » For heater voltage over 240V, or heater currents over 30 amps, or three-phase supply, the thermostat is used for pilot duty only and is not factory wired to the elements.

FIG.2 – CONSTRUCTION – Features and Components

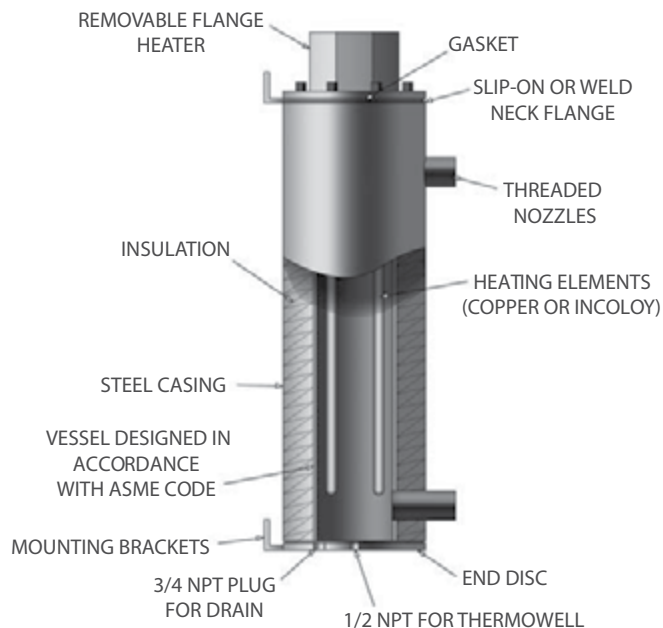

# CIRCULATION HEATERS

## immersion heaters

### GENERAL PRINCIPLES:

- » The heat you get from an electric heater will leave the heater, as opposed to the steam or liquid heat exchanger.
- » Even when the surface area in contact with the application is properly fixed, the sheath temperature of the heating element will increase until the heat achieved is similar to the heat that is transferred to the process.
- » Low watt density heaters last longer than high density heaters, particularly with viscous or stagnant liquids. Low density heaters are however more expensive.

### WARNING:

Selecting the wrong watt density can damage the product and control systems that are in place, and cause the heater to fail.

### SELECTING WATTCO™ CIRCULATION HEATER

When heating liquids (forced flow and natural flow heating loops):

- » Make sure that the heater vessel remains totally filled when in use
- » Use a circulator pump to achieve forced flow heating for heavier liquids or high temperature liquids heating purposes
- » Set natural flow systems to "side arm" water heating applications
- » Mount the heater in the vertical position where top of the heater is below the minimum liquid level of the tank

When heating gases (steam superheating, heating compressed air, nitrogen, ammonia):

- » Make sure that there is enough flow in order to maintain the maximum allowable vessel and sheath temperatures.

### NEED ASSISTANCE?

Please call us at **(1-888-226-8522)** if you still need further assistance in selecting the circulation heater that best suits the requirements of your application.

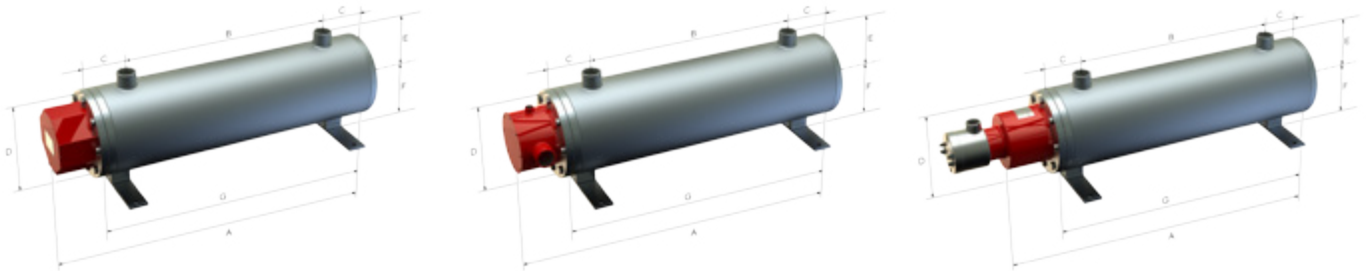

## HOW TO INSTALL:

The following figures show the proper vertical or horizontal mountings for vessels.



**FIG.3 – LIQUID HEATING or LOW TEMPERATURE GAS HEATING - VERTICAL INSTALLATION**



**FIG.4 – GAS or LIQUID HEATING HORIZONTAL INSTALLATION**



**FIG.5 – HIGH TEMPERATURE GAS HEATING VERTICAL INSTALLATION**

# CIRCULATION HEATERS

## immersion heaters

### WATTCO™ MINIATURE CIRCULATION HEATERS

- » Economical heat sources for several applications
- » No mounting support in stationary systems

### CONSTRUCTION

- » Basic construction:
  - 1" or 1 ¼" pipe fitted with a pipe "T" to fit a screwplug heater
  - Insulated pipe with 1 ¼" – 1 ½" of insulation protected by a steel casing of 20 ga.
- » Supplied units:
  - With or without thermostats
  - With general-purpose, moisture resistant, or explosion-proof terminal housings

- » If the outlet liquid or gas temperature is above 150°C (300°F):
  - Take the farthest end from the terminal box as the outlet
- » If the outlet liquid or gas temperature is under 150°C (300°F):
  - Take the outside threaded connection as the system inlet

### EXTRA FEATURES

- » Stainless steel wetted parts
- » Moisture resistant or explosion-proof housings
- » Special wattage (length increases when the watt density is the same)
- » Special thermostat range

FIG.1 – UNIT WITH BUILT-IN THERMOSTAT SHOWN

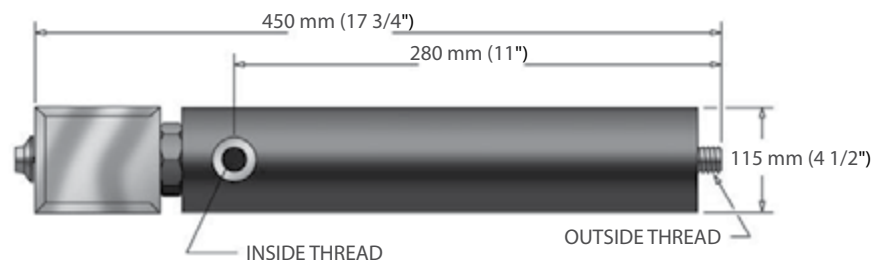

APPLICATIONS	SHEATH MATERIAL	SCREWPLUG or FLANGE MATERIAL	HEATER TYPE
Water Glycol water solutions Low viscosity liquids, not corrosive to brass or copper	Copper Steel	Brass Steel	MSX
Oils Low pressure steam Preheating instrument air	Incoloy®	Steel	MWHI

**Note:** Select lower watt density heaters for heavier liquids.

Incoloy® and Inconel® are registered trademarks of Inco Alloys International

TABLE 1  
Miniature Circulation Heaters

KILOWATTS	STANDARD VOLTAGES 1 PHASE ONLY	WATT DENSITY (W/cm <sup>2</sup> ) (W/in. <sup>2</sup> )		WITHOUT THERMOSTAT CAT. No.	WITH THERMOSTAT 10 - 120°C (50 - 250°F) CAT. No.	NET WT. (KG)
<b>TYPE MSX - COPPER SHEATH (BRASS PLUG &amp; VESSEL WITH 1" NPT CONNECTIONS)</b>						
1.0	120, 208, 240	12.4	80	MSX110B	MSX110BT	13.2 (6)
1.5	"	12.4	80	MSX115B	MSX115BT	13.2 (6)
2.0	"	12.4	80	MSX120B	MSX120BT	13.2 (6)
3.0	208, 240	12.4	80	MSX130B	MSX130BT	13.2 (6)
<b>TYPE MWHI - INCOLOY SHEATH (STEEL PLUG &amp; VESSEL WITH 1 1/4" NPT CONNECTIONS)</b>						
0.6	120, 208, 240	2.3	15	MWHI206EO	MWHI206EOT	17.6 (8)
1.0	"	3.9	25	MWHI210EO	MWHI210EOT	17.6 (8)

**WHEN ORDERING, PLEASE SPECIFY:** Quantity, catalogue number, voltage, phase, wattage, material to be heated, flowing or static mediums, types of controls to be applied, type of metal or alloy of the container, any extra features.

# CIRCULATION HEATERS

## immersion heaters

### 3" CIRCULATION HEATERS...GENERAL RECOMMENDATIONS - (ALSO APPLICABLE TO: 4" 5" 6" 8" 10" 12" 14" Circulation Heaters)

APPLICATIONS	SHEATH MATERIAL	HEATER TYPE
Water or aqueous solutions not corrosive to the steel vessel and copper sheath Dishwashing and rinsing Hot water storage tanks Process water	Copper	MFLC
Water (spray washing systems with chemical additives corrosive to copper)	Incoloy®	MFLI
Circulated oils Molding dies and platens Closed loop heat transfer systems Process liquids not corrosive to steel and incoloy® Compressed air or other gases	Steel	MFLO
Fluid heat transfer devices Tars High to low viscous petroleum oils Asphalt - Wax - Molten salt	Low Carbon Steel	MFLO
Deionized water	Stainless	MFLI

**Note:** When heating compressed air or gases, please verify if you need lower density heaters for high viscosity liquids or high temperature, low flow steam or gas heating systems. Call us at **(1-888-226-8522)** for technical assistance.

#### HEATER DIMENSIONS IN: mm (in.)

VESSEL SIZE	A	B	C	D	E	F	G
3"	1060 (41.7)	780 (30.7)	85 (3.3)	190 (7.5)	235 (9.3)	135 (5.3)	945 (37.2)

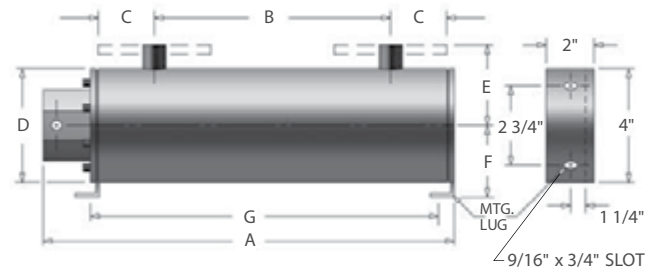

TABLE 2

#### 3" - 150 lb. Flanged Steel Vessel with 1" Inlet and Outlet

KILOWATTS	B DIM		STANDARD VOLTAGES				WATT DENSITY		WITHOUT THERMOSTAT CAT. No.	WITH THERMOSTAT 10 - 120°C (50 - 250°F) CAT. No.	NET WT. LBS (KG)
	INLET/OUTLET mm	in.	208 1φ	240 3φ	480 1φ	600 3φ	W/cm <sup>2</sup>	W/in. <sup>2</sup>			
<b>HIGH DENSITY - COPPER SHEATH</b>											
6	780	30.7	✓	✓	✓	✓	9.3	60	MFLC306X2418	MFLC306X2418T	108.6 (47)
9	780	30.7	✓	✓	✓	✓	8.5	55	MFLC309X2426	MFLC309X2426T	105.8 (48)
12	780	30.7	✓	✓	✓	✓	8.4	54	MFLC312X2432	MFLC312X2432T	105.8 (48)
18	780	30.7	✓	✓	✓	✓	8.5	55	MFLC618X2425	MFLC618X2425T	112.4 (51)
24	780	30.7	✓	✓	✓	✓	8.4	54	MFLC624X2432	MFLC624X2432T	112.4 (51)
<b>HIGH DENSITY - INCOLOY SHEATH</b>											
6	780	30.7	✓	✓	✓	✓	9.3	60	MFLI306X2418	MFLI306X2418T	108.6 (47)
9	780	30.7	✓	✓	✓	✓	8.5	55	MFLI309X2426	MFLI309X2426T	105.8 (48)
12	780	30.7	✓	✓	✓	✓	8.4	54	MFLI312X2432	MFLI312X2432T	105.8 (48)
18	780	30.7	✓	✓	✓	✓	8.5	55	MFLI618X2426	MFLI618X2426T	112.4 (51)
24	780	30.7	✓	✓	✓	✓	8.4	54	MFLI624X2432	MFLI624X2432T	112.4 (51)
<b>MEDIUM DENSITY - INCOLOY SHEATH</b>											
3	780	30.7	✓	✓	✓	✓	4.6	30	MFLI303X2418	MFLI303X2418T	108.6 (47)
4.5	780	30.7	✓	✓	✓	✓	4.2	27	MFLI304X2426	MFLI304X2426T	105.8 (48)
6	780	30.7	✓	✓	✓	✓	4.2	27	MFLI306X2432	MFLI306X2432T	105.8 (48)
<b>LOW DENSITY - INCOLOY SHEATH</b>											
3	780	30.7	✓	✓	✓	✓	2.1	14	MFLI303X2432	MFLI303X2432T	105.8 (48)

**WHEN ORDERING, PLEASE SPECIFY:** Quantity, catalogue number, voltage, phase, wattage, material to be heated, flowing or static mediums, types of controls to be applied, type of metal or alloy of the container, any extra features.

# CIRCULATION HEATERS

## immersion heaters

### 4" CIRCULATION HEATERS

Refer to PAGE 5 for the GENERAL RECOMMENDATIONS

HEATER DIMENSIONS IN: mm (in.)							
VESSEL SIZE	A	B	C	D	E	F	G
4"	1220 (48.0)	780 (30.7)	145 (5.7)	230 (9.1)	260 (10.2)	155 (6.1)	1065 (41.9)

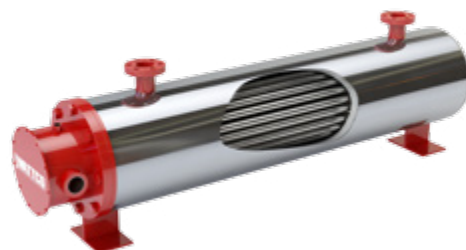
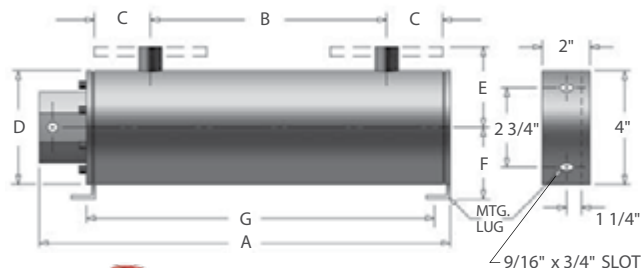

TABLE 3  
4" - 150 lb. Flanged Steel Vessel with 1 1/2" Inlet and Outlet

KILOWATTS	B DIM INLET/OUTLET		STANDARD VOLTAGES				WATT DENSITY		WITHOUT THERMOSTAT CAT. No.	WITH THERMOSTAT 10 - 120°C (50 - 250°F) CAT. No.	NET WT. LBS (KG)
	mm	in.	208 1φ	240 3φ	480 1φ	600 3φ	W/cm <sup>2</sup>	W/in. <sup>2</sup>			
<b>HIGH DENSITY - COPPER SHEATH</b>											
12	780	30.7	✓	✓	✓	✓	8.4	60	MFLC612X2818	MFLC612X2818T	138.9 (63)
15	780	30.7	✓	✓	✓	✓	8.8	57	MFLC615X2822	MFLC615X2822T	141.1 (64)
18	780	30.7	✓	✓	✓	✓	8.5	55	MFLC618X2826	MFLC618X2826T	141.1 (64)
24	780	30.7	✓	✓	✓	✓	8.4	54	MFLC624X2832	MFLC624X2832T	141.1 (64)
18	780	30.7	✓	✓	✓	✓	9.3	60	MFLC918X2818	MFLC918X2818T	147.7 (67)
27	780	30.7	✓	✓	✓	✓	8.5	55	MFLC927X2826	MFLC927X2826T	149.9 (68)
36	780	30.7	✓	✓	✓	✓	8.4	54	MFLC936X2832	MFLC936X2832T	152.1 (69)
<b>HIGH DENSITY - INCOLOY SHEATH</b>											
12	780	30.7	✓	✓	✓	✓	8.4	60	MFLI612X2818	MFLI612X2818T	138.9 (63)
15	780	30.7	✓	✓	✓	✓	8.8	57	MFLI615X2822	MFLI615X2822T	141.1 (64)
18	780	30.7	✓	✓	✓	✓	8.5	55	MFLI618X2825	MFLI618X2825T	141.1 (64)
24	780	30.7	✓	✓	✓	✓	8.4	54	MFLI624X2832	MFLI624X2832T	141.1 (64)
18	780	30.7	✓	✓	✓	✓	9.3	60	MFLI918X2818	MFLI918X2818T	147.7 (67)
27	780	30.7	✓	✓	✓	✓	8.5	55	MFLI927X2826	MFLI927X2826T	149.9 (68)
36	780	30.7	✓	✓	✓	✓	8.4	54	MFLI936X2832	MFLI936X2832T	152.1 (69)
<b>MEDIUM DENSITY - INCOLOY SHEATH</b>											
6	780	30.7	✓	✓	✓	✓	4.6	30	MFLI606X2818	MFLI606X2818T	138.9 (63)
9	780	30.7	✓	✓	✓	✓	4.2	27	MFLI609X2826	MFLI609X2826T	143.3 (65)
12	780	30.7	✓	✓	✓	✓	4.2	27	MFLI612X2832	MFLI612X2832T	143.3 (65)
9	780	30.7	✓	✓	✓	✓	4.6	30	MFLI909X2818	MFLI909X2818T	149.9 (68)
13.5	780	30.7	✓	✓	✓	✓	4.2	27	MFLI913X2825	MFLI913X2825T	152.1 (69)
18	780	30.7	✓	✓	✓	✓	4.2	27	MFLI918X2832	MFLI918X2832T	154.3 (70)
<b>LOW DENSITY - INCOLOY SHEATH</b>											
6	780	30.7	✓	✓	✓	✓	2.1	14	MFLI606X3032	MFLI606X3032T	143.3 (65)
9	780	30.7	✓	✓	✓	✓	2.1	14	MFLI909X3032	MFLI909X3032T	152.1 (69)

**WHEN ORDERING, PLEASE SPECIFY:** Quantity, catalogue number, voltage, phase, wattage, material to be heated, flowing or static mediums, types of controls to be applied, type of metal or alloy of the container, any extra features.

# CIRCULATION HEATERS

## immersion heaters

### 5" CIRCULATION HEATERS

Refer to PAGE 5 for the GENERAL RECOMMENDATIONS

HEATER DIMENSIONS IN: mm (in.)							
VESSEL SIZE	A	B	C	D	E	F	G
5"	1220 (48.0)	780 (30.7)	145 (5.7)	255 (10.0)	270 (10.6)	170 (6.7)	1065 (41.9)

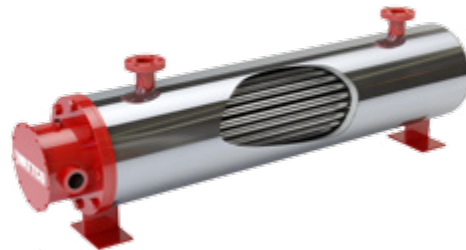
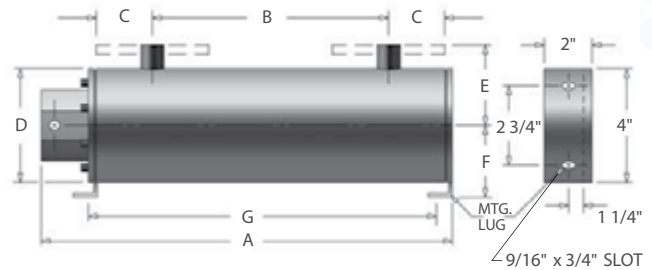

TABLE 4  
5" - 150 lb. Flanged Steel Vessel with 2" Inlet and Outlet

KILOWATTS	B DIM INLET/OUTLET		STANDARD VOLTAGES				WATT DENSITY		WITHOUT THERMOSTAT CAT. No.	WITH THERMOSTAT 10 - 120°C (50 - 250°F) CAT. No.	NET WT. LBS (KG)
	mm	in.	208 1φ	240 3φ	480 1φ	600 3φ	W/cm <sup>2</sup>	W/in. <sup>2</sup>			
<b>HIGH DENSITY - COPPER SHEATH</b>											
12	780	30.7	✓	✓	✓	✓	8.4	60	MFLC612X3018	MFLC612X3018T	138.9 (63)
15	780	30.7	✓	✓	✓	✓	8.8	57	MFLC615X3022	MFLC615X3022T	141.1 (64)
18	780	30.7	✓	✓	✓	✓	8.5	55	MFLC618X3026	MFLC618X3026T	141.1 (64)
24	780	30.7	✓	✓	✓	✓	8.4	54	MFLC624X3032	MFLC624X3032T	141.1 (64)
18	780	30.7	✓	✓	✓	✓	9.3	60	MFLC918X3018	MFLC918X3018T	147.7 (67)
27	780	30.7	✓	✓	✓	✓	8.5	55	MFLC927X3026	MFLC927X3026T	149.9 (68)
36	780	30.7	✓	✓	✓	✓	8.4	54	MFLC936X3032	MFLC936X3032T	152.1 (69)
<b>HIGH DENSITY - INCOLOY SHEATH</b>											
12	780	30.7	✓	✓	✓	✓	8.4	60	MFLI612X3018	MFLI612X3018T	138.9 (63)
15	780	30.7	✓	✓	✓	✓	8.8	57	MFLI615X3022	MFLI615X3022T	141.1 (64)
18	780	30.7	✓	✓	✓	✓	8.5	55	MFLI618X3025	MFLI618X3025T	141.1 (64)
24	780	30.7	✓	✓	✓	✓	8.4	54	MFLI624X3032	MFLI624X3032T	141.1 (64)
18	780	30.7	✓	✓	✓	✓	9.3	60	MFLI918X3018	MFLI918X3018T	147.7 (67)
27	780	30.7	✓	✓	✓	✓	8.5	55	MFLI927X3026	MFLI927X3026T	149.9 (68)
36	780	30.7	✓	✓	✓	✓	8.4	54	MFLI936X3032	MFLI936X3032T	152.1 (69)
<b>MEDIUM DENSITY - INCOLOY SHEATH</b>											
6	780	30.7	✓	✓	✓	✓	4.6	30	MFLI606X3018	MFLI606X3018T	138.9 (63)
9	780	30.7	✓	✓	✓	✓	4.2	27	MFLI609X3026	MFLI609X3026T	143.3 (65)
12	780	30.7	✓	✓	✓	✓	4.2	27	MFLI612X3032	MFLI612X3032T	143.3 (65)
9	780	30.7	✓	✓	✓	✓	4.6	30	MFLI909X3018	MFLI909X3018T	149.9 (68)
13.5	780	30.7	✓	✓	✓	✓	4.2	27	MFLI913X3025	MFLI913X3025T	152.1 (69)
18	780	30.7	✓	✓	✓	✓	4.2	27	MFLI918X3032	MFLI918X3032T	154.3 (70)
<b>LOW DENSITY - INCOLOY SHEATH</b>											
6	780	30.7	✓	✓	✓	✓	2.1	14	MFLI606X3032	MFLI606X3032T	143.3 (65)
9	780	30.7	✓	✓	✓	✓	2.1	14	MFLI909X3032	MFLI909X3032T	152.1 (69)

**WHEN ORDERING, PLEASE SPECIFY:** Quantity, catalogue number, voltage, phase, wattage, material to be heated, flowing or static mediums, types of controls to be applied, type of metal or alloy of the container, any extra features.



# CIRCULATION HEATERS

## immersion heaters

### 6" CIRCULATION HEATERS

Refer to PAGE 5 for the GENERAL RECOMMENDATIONS

#### HEATER DIMENSIONS IN: mm (in.)

VESSEL SIZE	A	B	C	D	E	F	G
6"	1220	780	145	280	290	180	1065
	(48.0)	(30.7)	(5.7)	(11.0)	(11.4)	(7.1)	(41.9)
6"	1540	1100	145	280	290	180	1385
	(60.6)	(43.3)	(5.7)	(11.0)	(11.4)	(7.1)	(54.5)

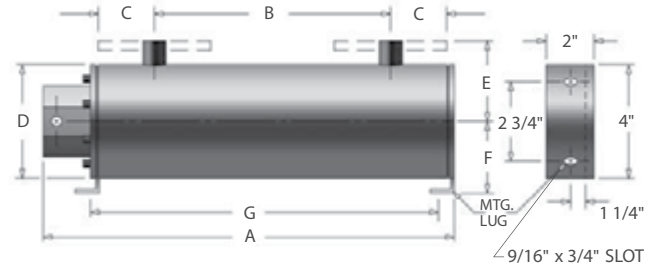

TABLE 5

6" - 150 lb. Flanged Steel Vessel with 2" Inlet and Outlet

KILOWATTS	B DIM		STANDARD VOLTAGES				WATT DENSITY		WITHOUT THERMOSTAT CAT. No.	WITH THERMOSTAT 10 - 120°C (50 - 250°F) CAT. No.	NET WT. LBS (KG)
	INLET/OUTLET mm	in.	208 1φ	240 3φ	480 1φ	600 3φ	W/cm <sup>2</sup>	W/in. <sup>2</sup>			
<b>HIGH DENSITY - COPPER SHEATH</b>											
36	780	30.7	✓	✓	✓	✓	8.5	55	MFLC1236X1026	MFLC1236X1026T	200.6 (91)
48	780	30.7	—	✓	✓	✓	8.4	54	MFLC1248X1032	MFLC1248X1032T	202.8 (92)
60	1100	43.3	—	✓	✓	✓	8.4	54	MFLC1260X1039	MFLC1260X1039T	209.4 (95)
72	1100	43.3	—	✓	✓	✓	8.2	53	MFLC1272X1047	MFLC1272X1047T	211.6 (96)
45	780	30.7	—	✓	✓	✓	8.5	55	MFLC1545X1026	MFLC1545X1026T	205.0 (93)
60	780	30.7	—	✓	✓	✓	8.4	54	MFLC1560X1032	MFLC1560X1032T	211.6 (96)
75	1100	43.3	—	✓	✓	✓	8.4	54	MFLC1575X1039	MFLC1575X1039T	240.3 (109)
90	1100	43.3	—	—	✓	✓	8.2	53	MFLC1590X1047	MFLC1590X1047T	246.9 (112)
90	1100	43.3	—	—	✓	✓	8.4	54	MFLC1890X1039	MFLC1890X1039T	246.9 (112)
<b>HIGH DENSITY - INCOLOY SHEATH</b>											
36	780	30.7	✓	✓	✓	✓	8.5	55	MFLI1236X1026	MFLI1236X1026T	200.6 (91)
48	780	30.7	—	✓	✓	✓	8.4	54	MFLI1248X1032	MFLI1248X1032T	202.8 (92)
60	1100	43.3	—	✓	✓	✓	8.4	54	MFLI1260X1039	MFLI1260X1039T	209.4 (95)
72	1100	43.3	—	✓	✓	✓	8.2	53	MFLI1272X1047	MFLI1272X1047T	211.6 (96)
45	780	30.7	—	✓	✓	✓	8.5	55	MFLI1545X1026	MFLI1545X1026T	205.0 (93)
60	780	30.7	—	✓	✓	✓	8.4	54	MFLI1560X1032	MFLI1560X1032T	211.6 (96)
75	1100	43.3	—	✓	✓	✓	8.4	54	MFLI1575X1039	MFLI1575X1039T	240.3 (109)
90	1100	43.3	—	—	✓	✓	8.2	53	MFLI1590X1047	MFLI1590X1047T	246.9 (112)
90	1100	43.3	—	—	✓	✓	8.4	54	MFLI1890X1039	MFLI1890X1039T	246.9 (112)
120	1100	43.3	—	—	—	✓	10.9	70	MFLI15120X1047	MFLI15120X1047T	251.3 (114)
144	1100	43.3	—	—	—	✓	10.9	70	MFLI18144X1047	MFLI18144X1047T	260.2 (118)
<b>MEDIUM DENSITY - INCOLOY SHEATH</b>											
18	780	30.7	✓	✓	✓	✓	4.2	27	MFLI1218X1025	MFLI1218X1025T	202.8 (92)
24	780	30.7	✓	✓	✓	✓	4.2	27	MFLI1224X1032	MFLI1224X1032T	207.2 (94)
30	1100	43.3	✓	✓	✓	✓	4.2	27	MFLI1230X1039	MFLI1230X1039T	233.7 (106)
36	1100	43.3	✓	✓	✓	✓	4.1	26	MFLI1236X1047	MFLI1236X1047T	238.1 (108)
22.5	780	30.7	✓	✓	✓	✓	4.2	27	MFLI1522X1025	MFLI1522X1025T	209.4 (95)
30	780	30.7	✓	✓	✓	✓	4.2	27	MFLI1530X1032	MFLI1530X1032T	213.8 (97)
37.5	1100	43.3	✓	✓	✓	✓	4.2	27	MFLI1537X1039	MFLI1537X1039T	240.3 (109)
45	1100	43.3	—	✓	✓	✓	4.1	26	MFLI1545X1047	MFLI1545X1047T	246.9 (112)
<b>LOW DENSITY - INCOLOY SHEATH</b>											
12	780	30.7	✓	✓	✓	✓	2.1	14	MFLI1212X1032	MFLI1212X1032T	202.8 (92)
18	1100	43.3	✓	✓	✓	✓	2.5	16	MFLI1218X1039	MFLI1218X1039T	233.7 (106)
24	1100	43.3	✓	✓	✓	✓	2.7	18	MFLI1224X1047	MFLI1224X1047T	244.7 (111)
15	780	30.7	✓	✓	✓	✓	2.1	14	MFLI1515X1032	MFLI1515X1032T	209.4 (95)
22.5	1100	43.3	✓	✓	✓	✓	2.5	16	MFLI1522X1039	MFLI1522X1039T	242.5 (110)
30	1100	43.3	✓	✓	✓	✓	2.7	18	MFLI1530X1047	MFLI1530X1047T	253.5 (115)

**WHEN ORDERING, PLEASE SPECIFY:** Quantity, catalogue number, voltage, phase, wattage, material to be heated, flowing or static mediums, types of controls to be applied, type of metal or alloy of the container, any extra features.

# CIRCULATION HEATERS

## immersion heaters

### 8" CIRCULATION HEATERS

Refer to PAGE 5 for the GENERAL RECOMMENDATIONS

HEATER DIMENSIONS IN: mm (in.)							
VESSEL SIZE	A	B	C	D	E	F	G
8"	1580 (62.2)	1100 (43.3)	165 (6.5)	345 (13.6)	330 (13.0)	215 (8.5)	1425 (56.1)

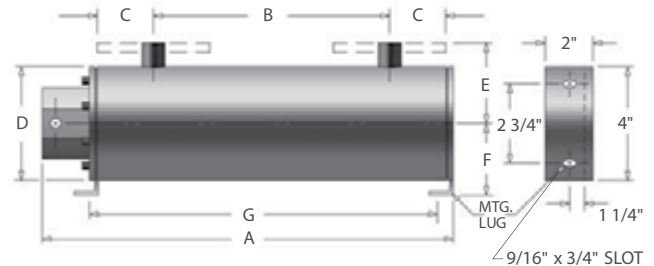

TABLE 6

8" - 150 lb. Flanged Steel Vessel with 2 1/2" Inlet and Outlet

KILOWATTS	B DIM		STANDARD VOLTAGES				WATT DENSITY		WITHOUT THERMOSTAT CAT. No.	WITH THERMOSTAT 10 - 120°C (50 - 250°F) CAT. No.	NET WT. LBS (KG)
	INLET/OUTLET mm	in.	208 1φ	240 3φ	480 1φ	600 3φ	W/cm <sup>2</sup>	W/in. <sup>2</sup>			
<b>HIGH DENSITY - COPPER SHEATH</b>											
54	1100	43.3	—	✓	✓	✓	8.5	55	MFLC1854X1225	MFLC1854X1225T	233.7 (106)
72	1100	43.3	—	✓	✓	✓	8.4	54	MFLC1872X1232	MFLC1872X1232T	240.3 (109)
90	1100	43.3	—	✓	✓	✓	8.4	54	MFLC1890X1239	MFLC1890X1239T	313.6 (142)
108	1100	43.3	—	✓	✓	✓	8.2	53	MFLC18108X1247	MFLC18108X1247T	317.5 (144)
81	1100	43.3	—	✓	✓	✓	8.5	55	MFLC2781X1225	MFLC2781X1225T	326.3 (148)
108	1100	43.3	—	✓	✓	✓	8.4	54	MFLC27108X1232	MFLC27108X1232T	335.1 (152)
135	1100	43.3	—	—	—	✓	8.4	54	MFLC27135X1239	MFLC27135X1239T	346.1 (157)
162	1100	43.3	—	—	—	✓	8.2	53	MFLC27162X1247	MFLC27162X1247T	352.7 (160)
<b>HIGH DENSITY - INCOLOY SHEATH</b>											
54	1100	43.3	—	✓	✓	✓	8.5	55	MFLI1854X12	MFLI1854X12T	233.7 (106)
72	1100	43.3	—	✓	✓	✓	8.4	54	MFLI1872X12	MFLI1872X12T	240.3 (109)
90	1100	43.3	—	✓	✓	✓	8.4	54	MFLI1890X12	MFLI1890X12T	313.6 (142)
108	1100	43.3	—	✓	✓	✓	8.2	53	MFLI18108X12	MFLI18108X12T	317.5 (144)
81	1100	43.3	—	✓	✓	✓	8.5	55	MFLI2781X12	MFLI2781X12T	326.3 (148)
108	1100	43.3	—	✓	✓	✓	8.4	54	MFLI27108X12	MFLI27108X12T	335.1 (152)
135	1100	43.3	—	—	—	✓	8.4	54	MFLI27135X12	MFLI27135X12T	346.1 (157)
162	1100	43.3	—	—	—	✓	8.2	53	MFLI27162X12	MFLI27162X12T	352.7 (160)
120	1100	43.3	—	—	—	✓	10.9	70	MFLI15120X12	MFLI15120X12T	313.6 (142)
144	1100	43.3	—	—	—	✓	10.9	70	MFLI18144X12	MFLI18144X12T	319.7 (145)
168	1100	43.3	—	—	—	✓	10.9	70	MFLI21168X12	MFLI21168X12T	326.3 (148)
192	1100	43.3	—	—	—	✓	10.9	70	MFLI24192X12	MFLI24192X12T	332.9 (151)
216	1100	43.3	—	—	—	✓	10.9	70	MFLI27216X12	MFLI27216X12T	339.5 (154)
240	1100	43.3	—	—	—	✓	10.9	70	MFLI30240X12	MFLI30240X12T	346.1 (157)
<b>MEDIUM DENSITY - INCOLOY SHEATH</b>											
36	1100	43.3	✓	✓	✓	✓	4.2	27	MFLI1836X1232	MFLI1836X1232T	304.2 (138)
54	1100	43.3	—	✓	✓	✓	4.1	26	MFLI1854X1247	MFLI1854X1247T	319.7 (145)
63	1100	43.3	—	✓	✓	✓	4.1	26	MFLI2163X1247	MFLI2163X1247T	328.5 (149)
72	1100	43.3	—	✓	✓	✓	4.1	26	MFLI2436X1247	MFLI2436X1247T	335.1 (152)
81	1100	43.3	—	✓	✓	✓	4.1	26	MFLI2781X1247	MFLI2781X1247T	341.7 (155)
90	1100	43.3	—	✓	✓	✓	4.1	26	MFLI3090X1247	MFLI3090X1247T	348.3 (158)
<b>LOW DENSITY - INCOLOY SHEATH</b>											
27	1100	43.3	✓	✓	✓	✓	2.5	16	MFLI1827X1239	MFLI1827X1239T	313.6 (142)
31.5	1100	43.3	✓	✓	✓	✓	2.5	16	MFLI2131X1239	MFLI2131X1239T	317.5 (144)
36	1100	43.3	✓	✓	✓	✓	2.5	16	MFLI2436X1239	MFLI2436X1239T	321.9 (146)
36	1100	43.3	✓	✓	✓	✓	2.7	17	MFLI1836X1247	MFLI1836X1247T	321.9 (146)
40.5	1100	43.3	—	✓	✓	✓	2.5	16	MFLI2740X1239	MFLI2740X1239T	328.5 (149)
45	1100	43.3	—	✓	✓	✓	2.5	16	MFLI3045X1239	MFLI3045X1239T	335.1 (152)
54	1100	43.3	—	✓	✓	✓	2.7	17	MFLI2754X1247	MFLI2754X1247T	343.9 (156)

**WHEN ORDERING, PLEASE SPECIFY:** Quantity, catalogue number, voltage, phase, wattage, material to be heated, flowing or static mediums, types of controls to be applied, type of metal or alloy of the container, any extra features.

# CIRCULATION HEATERS

## immersion heaters

### 10" CIRCULATION HEATERS

Refer to PAGE 5 for the GENERAL RECOMMENDATIONS

HEATER DIMENSIONS IN: mm (in.)							
VESSEL SIZE	A	B	C	D	E	F	G
10"	1650 (65.0)	1100 (43.3)	180 (7.1)	405 (16.0)	375 (14.8)	250 (9.9)	1450 (57.1)

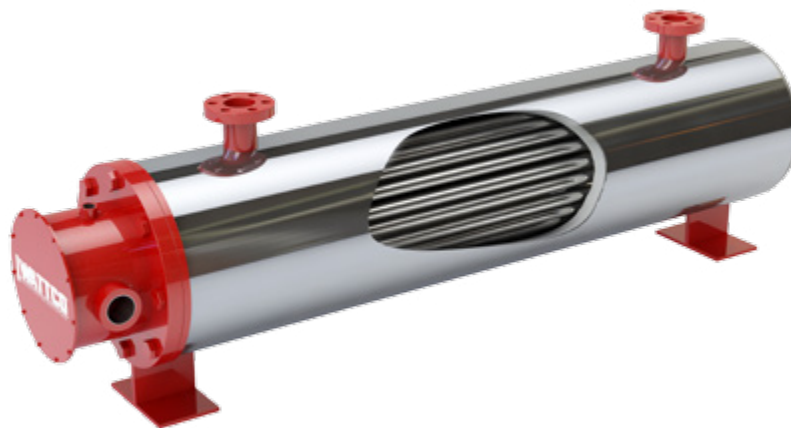
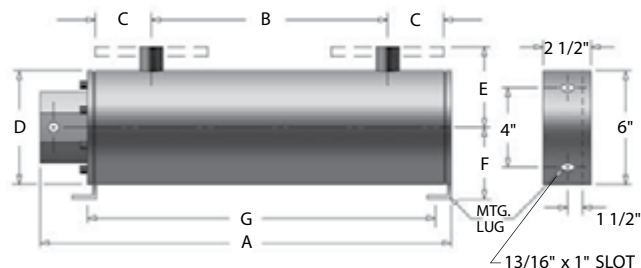

TABLE 7

10" - 150 lb. Flanged Steel Vessel with 3" Inlet and Outlet

KILOWATTS	B DIM INLET/OUTLET		STANDARD VOLTAGES				WATT DENSITY		WITHOUT THERMOSTAT CAT. No.	WITH THERMOSTAT 10 - 120°C (50 - 250°F) CAT. No.	NET WT. LBS (KG)
	mm	in.	208 1φ	240 3φ	480 1φ	600 3φ	W/cm <sup>2</sup>	W/in. <sup>2</sup>			
<b>HIGH DENSITY - COPPER SHEATH</b>											
108	1100	43.3	—	—	—	✓	9.8	63	MFLC36180X1439	MFLC36180X1439T	485.0 (220)
216	1100	43.3	—	—	—	✓	9.3	60	MFLC36216X1447	MFLC36216X1447T	498.2 (226)
252	1100	43.3	—	—	—	✓	9.3	60	MFLC42252X1447	MFLC42252X1447T	520.3 (236)
<b>HIGH DENSITY - INCOLOY SHEATH</b>											
180	1100	43.3	—	—	—	✓	9.8	63	MFLI36180X1439	MFLI36180X1439T	485.0 (220)
216	1100	43.3	—	—	—	✓	9.3	60	MFLI36216X1447	MFLI36216X1447T	498.2 (226)
252	1100	43.3	—	—	—	✓	9.3	60	MFLI42252X1447	MFLI42252X1447T	520.3 (236)
288	1100	43.3	—	—	—	✓	12.3	80	MFLI36288X1447	MFLI36288X1447T	498.2 (226)
336	1100	43.3	—	—	—	✓	12.3	80	MFLI42336X1447	MFLI42336X1447T	520.3 (236)
384	1100	43.3	—	—	—	✓	12.3	80	MFLI48384X1447	MFLI48384X1447T	542.3 (246)
<b>MEDIUM DENSITY - INCOLOY SHEATH</b>											
108	1100	43.3	—	—	✓	✓	4.6	30	MFLI36108X1447	MFLI36108X1447T	498.2 (226)
126	1100	43.3	—	—	—	✓	4.6	30	MFLI42336X1447	MFLI42336X1447T	520.3 (236)
144	1100	43.3	—	—	—	✓	4.6	30	MFLI48384X1447	MFLI48384X1447T	537.9 (244)
<b>LOW DENSITY - INCOLOY SHEATH</b>											
72	1100	43.3	—	✓	✓	✓	3.1	20	MFLI3672X1447	MFLI3672X1447T	498.2 (226)
84	1100	43.3	—	✓	✓	✓	3.1	20	MFLI4284X1447	MFLI4284X1447T	520.3 (236)
96	1100	43.3	—	✓	✓	✓	3.1	20	MFLI4896X1447	MFLI4896X1447T	537.9 (244)

**WHEN ORDERING, PLEASE SPECIFY:** Quantity, catalogue number, voltage, phase, wattage, material to be heated, flowing or static mediums, types of controls to be applied, type of metal or alloy of the container, any extra features.

# CIRCULATION HEATERS

## immersion heaters

### 12" CIRCULATION HEATERS

Refer to PAGE 5 for the GENERAL RECOMMENDATIONS

HEATER DIMENSIONS IN: mm (in.)

VESSEL SIZE	A	B	C	D	E	F	G
12"	1655 (65.1)	1100 (43.3)	180 (7.1)	480 (19.0)	410 (16.1)	290 (11.5)	1450 (57.1)

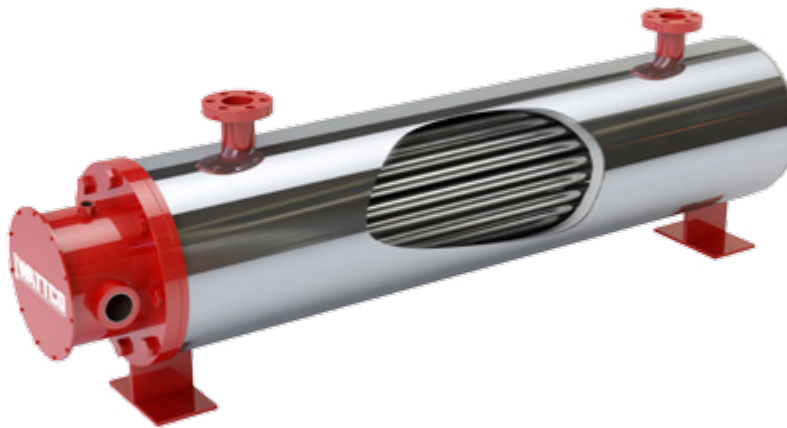
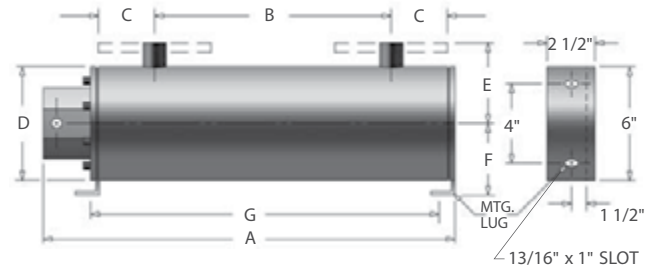

TABLE 8

12" - 150 lb. Flanged Steel Vessel with 3" Inlet and Outlet

KILOWATTS	B DIM		STANDARD VOLTAGES				WATT DENSITY		WITHOUT THERMOSTAT CAT. No.	WITH THERMOSTAT 10 - 120°C (50 - 250°F) CAT. No.	NET WT. LBS (KG)
	INLET/OUTLET mm	in.	208 1φ	240 3φ	480 1φ	600 3φ	W/cm <sup>2</sup>	W/in. <sup>2</sup>			
<b>HIGH DENSITY - COPPER SHEATH</b>											
240	1100	43.3	—	—	—	✓	9.8	63	MFLC48240X1639	MFLC48240X1639T	690.1 (313)
288	1100	43.3	—	—	—	✓	9.3	60	MFLC48288X1647	MFLC48288X1647T	709.9 (322)
324	1100	43.3	—	—	—	✓	9.3	60	MFLC54324X1647	MFLC54324X1647T	727.5 (330)
360	1100	43.3	—	—	—	✓	9.3	60	MFLC60360X1647	MFLC60360X1647T	718.7 (326)
<b>HIGH DENSITY - INCOLOY SHEATH</b>											
240	1100	43.3	—	—	—	✓	9.8	63	MFLI48240X1639	MFLI48240X1639T	690.1 (313)
288	1100	43.3	—	—	—	✓	9.3	60	MFLI48288X1647	MFLI48288X1647T	709.9 (322)
324	1100	43.3	—	—	—	✓	9.3	60	MFLI54324X1647	MFLI54324X1647T	727.5 (330)
360	1100	43.3	—	—	—	✓	9.3	60	MFLI60360X1647	MFLI60360X1647T	718.7 (326)
432	1100	43.3	—	—	—	✓	12.3	80	MFLI54432X1647	MFLI54432X1647T	727.5 (330)
480	1100	43.3	—	—	—	✓	12.3	80	MFLI60480X1647	MFLI60480X1647T	743.0 (337)
<b>MEDIUM DENSITY - INCOLOY SHEATH</b>											
144	1100	43.3	—	—	—	✓	4.6	30	MFLI48144X1647	MFLI48144X1647T	709.9 (322)
162	1100	43.3	—	—	—	✓	4.6	30	MFLI54162X1647	MFLI54162X1647T	727.5 (330)
180	1100	43.3	—	—	—	✓	4.6	30	MFLI60180X1647	MFLI60180X1647T	743.0 (337)
<b>LOW DENSITY - INCOLOY SHEATH</b>											
96	1100	43.3	—	✓	✓	✓	3.1	20	MFLI4896X1647	MFLI4896X1647T	709.9 (322)
108	1100	43.3	—	—	✓	✓	3.1	20	MFLI54108X1647	MFLI54108X1647T	727.5 (330)
120	1100	43.3	—	—	—	✓	3.1	20	MFLI60120X1647	MFLI60120X1647T	743.0 (337)

**WHEN ORDERING, PLEASE SPECIFY:** Quantity, catalogue number, voltage, phase, wattage, material to be heated, flowing or static mediums, types of controls to be applied, type of metal or alloy of the container, any extra features.

# CIRCULATION HEATERS

## immersion heaters

### 14" CIRCULATION HEATERS

Refer to PAGE 5 for the GENERAL RECOMMENDATIONS

HEATER DIMENSIONS IN: mm (in.)

VESSEL SIZE	A	B	C	D	E	F	G
14"	1680 (66.2)	1100 (43.3)	220 (7.8)	535 (21.0)	445 (17.5)	320 (12.6)	1490 (58.6)

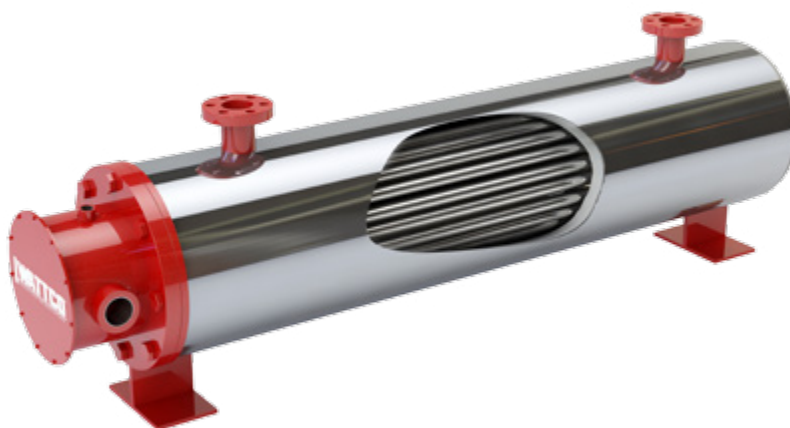
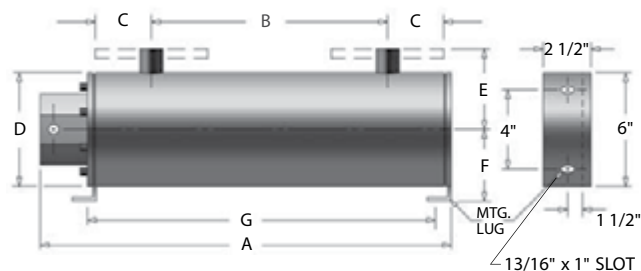

TABLE 9

14" - 150 lb. Flanged Steel Vessel with 3" Inlet and Outlet

KILOWATTS	B DIM INLET/OUTLET		STANDARD VOLTAGES				WATT DENSITY		WITHOUT THERMOSTAT CAT. No.	WITH THERMOSTAT 10 - 120°C (50 - 250°F) CAT. No.	NET WT. LBS (KG)
	mm	in.	208 1φ	240 3φ	480 1φ	600 3φ	W/cm <sup>2</sup>	W/in. <sup>2</sup>			
<b>HIGH DENSITY - COPPER SHEATH</b>											
300	1100	43.3	—	—	—	✓	9.8	63	MFLC60300X1839	MFLC60300X1839T	877.4 (398)
360	1100	43.3	—	—	—	✓	9.3	60	MFLC60360X1847	MFLC60360X1847T	903.9 (410)
432	1100	43.3	—	—	—	✓	9.3	60	MFLC72432X1847	MFLC72432X1847T	934.8 (424)
504	1100	43.3	—	—	—	✓	9.3	60	MFLC84504X1847	MFLC84504X1847T	967.8 (439)
<b>HIGH DENSITY - INCOLOY SHEATH</b>											
300	1100	43.3	—	—	—	✓	9.8	63	MFLI60300X1839	MFLI60300X1839T	877.4 (398)
360	1100	43.3	—	—	—	✓	9.3	60	MFLI60360X1847	MFLI60360X1847T	903.9 (410)
432	1100	43.3	—	—	—	✓	9.3	60	MFLI72432X1847	MFLI72432X1847T	934.8 (424)
504	1100	43.3	—	—	—	✓	9.3	60	MFLI84504X1847	MFLI84504X1847T	967.8 (439)
576	1100	43.3	—	—	—	✓	12.3	80	MFLI72576X1847	MFLI72576X1847T	934.8 (424)
672	1100	43.3	—	—	—	✓	12.3	80	MFLI84672X1847	MFLI84672X1847T	967.8 (439)
<b>MEDIUM DENSITY - INCOLOY SHEATH</b>											
180	1100	43.3	—	—	—	✓	4.6	30	MFLI60180X1847	MFLI60180X1847T	903.9 (410)
216	1100	43.3	—	—	—	✓	4.6	30	MFLI72216X1847	MFLI72216X1847T	934.8 (424)
252	1100	43.3	—	—	—	✓	4.6	30	MFLI84252X1847	MFLI84252X1847T	967.8 (439)
<b>LOW DENSITY - INCOLOY SHEATH</b>											
120	1100	43.3	—	✓	✓	✓	3.1	20	MFLI60120X1847	MFLI60120X1847T	903.9 (410)
144	1100	43.3	—	✓	✓	✓	3.1	20	MFLI72144X1847	MFLI72144X1847T	934.8 (424)
168	1100	43.3	—	✓	✓	✓	3.1	20	MFLI84168X1847	MFLI84168X1847T	967.8 (439)

**WHEN ORDERING, PLEASE SPECIFY:** Quantity, catalogue number, voltage, phase, wattage, material to be heated, flowing or static mediums, types of controls to be applied, type of metal or alloy of the container, any extra features.